

# Newdeal LUBRICATOR

- Lubricator with high lubrication stability.
- Quantity of lubricant proportioned to air flow
  - Micrometric regulation of lubricant flow
  - Activates at low flow rates
  - All-round oil level viewing



TECHNICAL DATA	LUB ND 1/4"	LUB ND 3/8"	LUB ND 1/2"	LUB ND 3/4"	LUB ND 1"
Threaded port	1/4"	3/8"	1/2"	3/4"	1"
Type of lubrication	mist				
Bowl capacity	50	150	380		
Max. inlet pressure	1.8 MPa - 18 bar - 261 psi				
Flow rate at 6.3 bar (0.63 MPa ÷ 91 psi)	700	3000	12800		
ΔP 0.5 bar (0.05 MPa ÷ 7 psi)	25	107	452		
Flow rate at 6.3 bar (0.63 MPa ÷ 91 psi)	1100	4300	16000		
ΔP 1 bar (0.1 MPa ÷ 14 psi)	39	153	565		
Fluid	Filtered compressed air				
Max temperature at 1 MPa; 10 bar; 145 psi	50°C - 122°F				
Weight	0.4	0.9	1.3		
Wall fixing screws	M4x40	M4x55	M6x75		
Mounting position	Vertical				
Notes:	<ul style="list-style-type: none"> <li>• Use the screw provided to set the drip rate to drop every 300-600 NI.</li> <li>• Fit the lubricator as close as possible to the point of use</li> <li>• Fill the bowl with oil before pressurizing the system</li> <li>• Do not use cleaning oil, brake fluid or solvents in general</li> <li>• Recommended lubricants: ISO and UNI FD22 - E.g. Energol HLP 22 (BP) - Spinesso 22 (Esso) - Mobil DTE 22 (Mobil) - Tellus Oil 22 (Shell)</li> </ul>				
On request:	<ul style="list-style-type: none"> <li>• Automatic filling lubricator and minimum level lubricator.</li> </ul>				

## COMPONENTS:

- ① Zamak body
- ② Rilsan oil suction pipe
- ③ Aluminium bowl
- ④ Clear technopolymer bowl
- ⑤ Filter
- ⑥ Technopolymer plug
- ⑦ Venturi NBR diaphragm
- ⑧ OT 58 brass oil flow regulation needle
- ⑨ Clear technopolymer cover
- ⑩ NBR gaskets

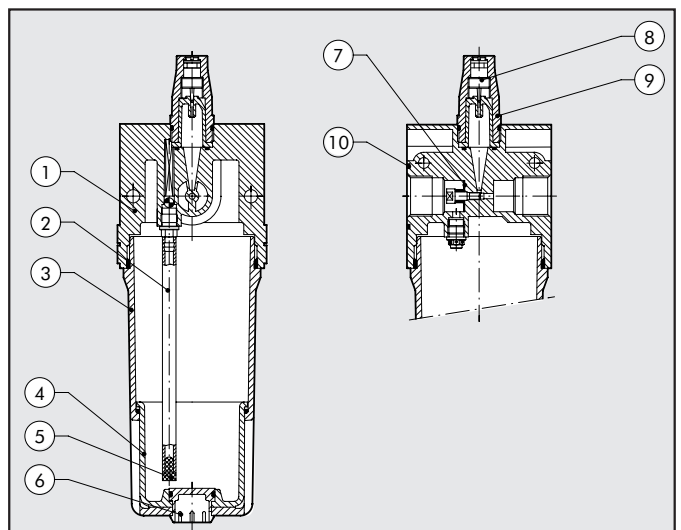

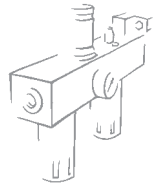

## FLOW CHARTS



**Department of Mechanics**  
Turin Polytechnic

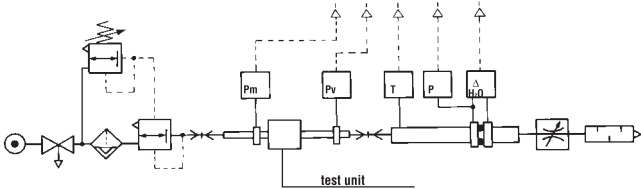

• Flow tests carried out at the Department of Mechanics, Turin Polytechnic, using the computerized test bench following CETOP RP50R recommendations (ISO DIS 6358-2-approved) with ISO 5167 diaphragm gauge.

- (A) = 2 bar - 0,2 MPa - 29 psi
- (B) = 4 bar - 0,4 MPa - 58 psi
- (C) = 6 bar - 0,6 MPa - 87 psi
- (D) = 8 bar - 0,8 MPa - 116 psi
- (E) = 10 bar - 1 MPa - 145 psi

### LUB 1/4

$\Delta P = (P_m - P_v)$   
psi KPa bar

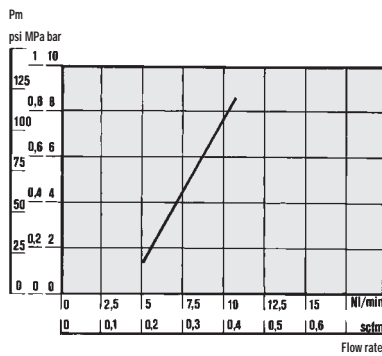
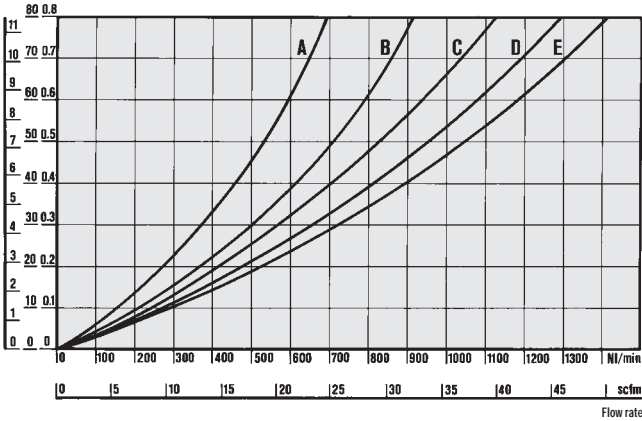

### • MINIMUM ACTIVATION FLOW CHARTS

The minimum activation flow charts were carried out in compliance with ISO/DP 6301/2

### LUB 3/8 - 1/2

$\Delta P = (P_m - P_v)$   
psi KPa bar

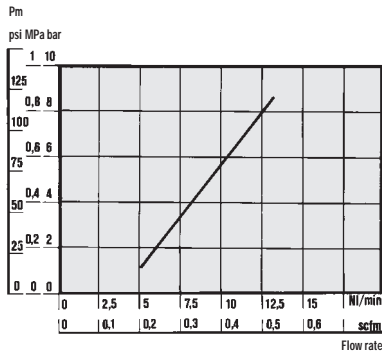
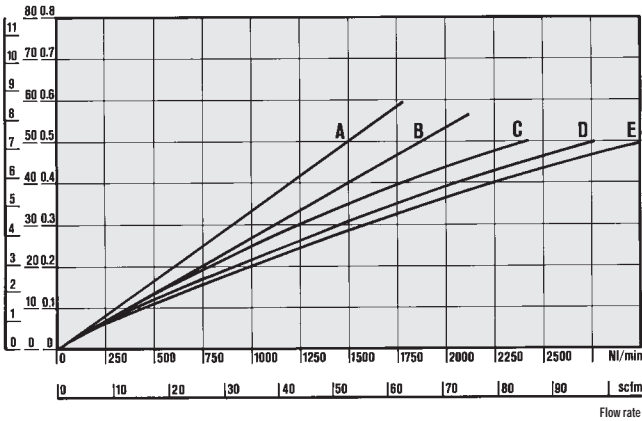

### • MINIMUM ACTIVATION FLOW CHARTS

The minimum activation flow charts were carried out in compliance with ISO/DP 6301/2

### LUB 3/4 - 1"

$\Delta P = (P_m - P_v)$   
psi KPa bar

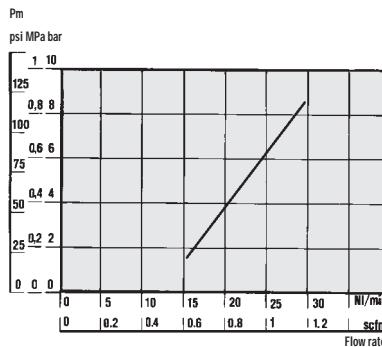
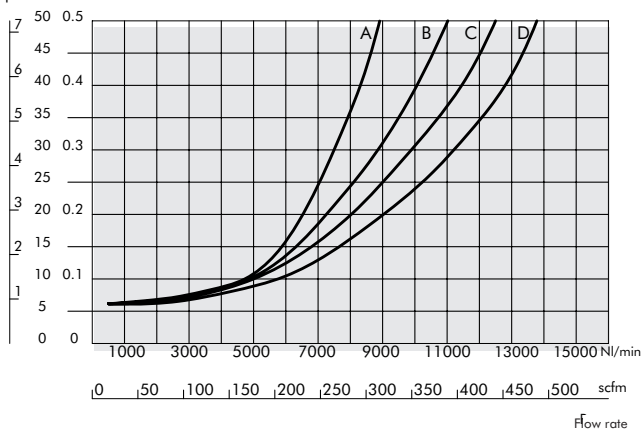

### • MINIMUM ACTIVATION FLOW CHARTS

The minimum activation flow charts were carried out in compliance with ISO/DP 6301/2

